

Metal bodied limit switch

Series MN78

Description **MN78-13 AHDM**

Article number **6087000096**

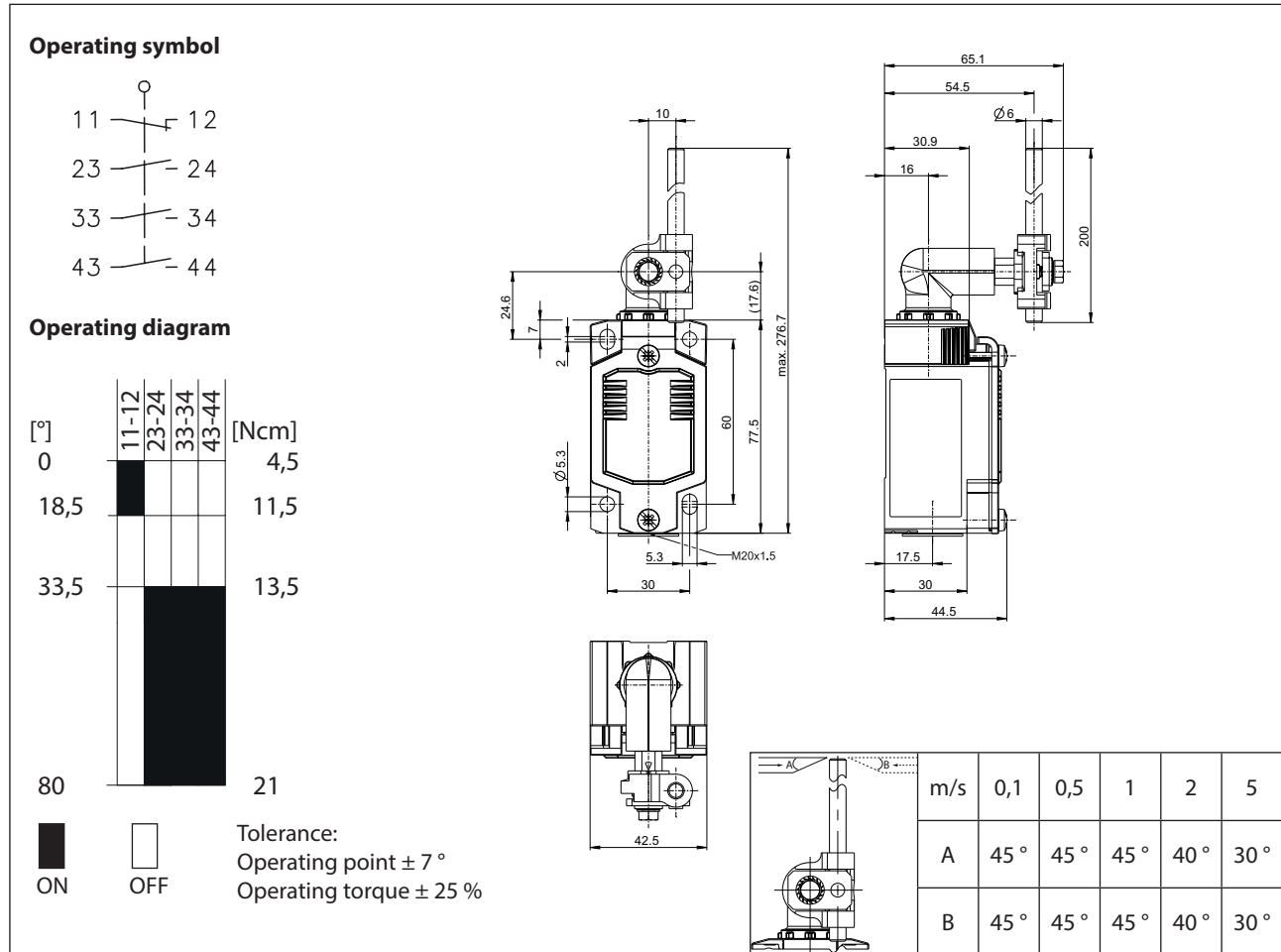

Electrical Data		
Rated insulation voltage	U_i	250 V
Rated impulse withstand voltage	U_{imp}	2,5 kV
Rated operational voltage	U_e	240 V AC / 24 V DC
Rated supply frequency AC		50 / 60 Hz
Conv. thermal current	I_{the}	5 A
Minimum current		1 mA
Utilization category		AC 15, U_e/I_e 240 V / 1,5 A; DC 13, U_e/I_e 24 V / 1,5 A
Short-circuit protective device		Fuse 4 A gG
Rated conditional short-circuit current		400 A
Protection class		I

Mechanical data	
Enclosure	Die-cast aluminium
Cover	Sheet aluminium
Actuator	Metal wire Ø6 mm / lever in 15 ° increments adjustable
Operating temperature	-30 °C ... +75 °C
Storage temperature	-40 °C ... +80 °C
Protection type	IP66 / IP67 acc. EN 60529, Type 4X
Pollution degree (built-in switch)	3
Contact material	silver
Contact type	1 N.C., 3 N.O.
Switching frequency	≤ 60 / min.
Mechanical life	10 x 10 ⁶ operating cycles
Mission time	≤20 years
Connection	8 screw connections (M3,5)
Earth bolt	1 x M3,5
Conductor cross-sections	Solid or Litz wire with ferrules 0,34 mm ² - 1,5 mm ² ; AWG 22-16
Cable entrance	1 x M20 x1,5
Weight	≈ 0,28 kg
Installation position	operator definable

Actuation
The actuating device is preferably started from 2 sides. The actuation assembly can be rotated in 45° increments such that 16 actuation directions are possible.

Standards
DIN EN 60947-5-1
UL 508 / CSA C22.2 No.14

EU Conformity
acc. to directive 2014/35/EU (Low-Voltage-Directive)

Approvals
CCC
cUL _{US}

Notes
The degree of protection (IP code) specified applies solely to a property closed cover and the use of an equivalent cable gland with adequate cable.